

Article number: 437900110

Description: Rota-fix shaft-hub connection SA 110

## Measures

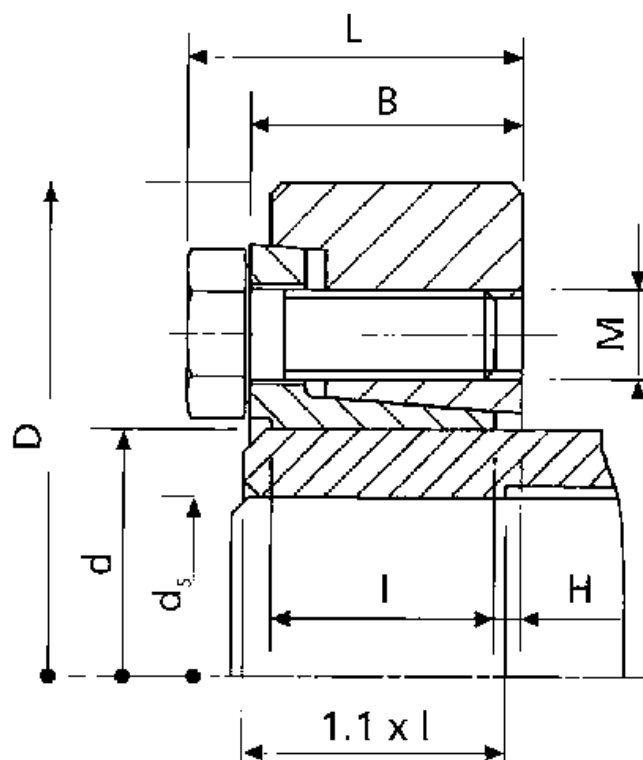

B mm	= 49.0
d H8 mm	= 110
D mm	= 185.0
ds mm	= 80
F kN torque	= 263
H	= 5.0
I mm	= 40.5
L mm	= 57.0

M mm	= M12
T N m torque	= 10500
Ts N m bolt tightening torque	= 100